

FEATURES

- Frequency Range:0.5-18GHz
- High Dynamic Range
- Compact size
- Excellent Linearity
- Precision,Reliability and Repeatability
- Economically Priced



APPLICATIONS

- Microwave Radio & VSAT
- Military & Space
- Test Instrumentation
- Frequency measurement

SPECIFICATIONS@25°C:

Part Number	Frequency Range (GHz)	TSS (dBm. Typ)	Flatness (±dB)Max	Dynamic Range (dBm)	Log Linearity (±dB Max)	VSWR Max	Current@ 12-15 VDC (mA. Typ)	Case Type
MDL001200D58	0.1-20	-58	1.5	-55~+5	1	2.5(Typ.)	120	DL11
MDL005020D72	0.5-2	-72	2	-70~+5	1	2	250/130	DL2
MDL005060D72	0.5-6	-72	2	-70~+5	1	2	250/130	DL2
MDL005180D68	0.5-18	-68	3	-40~+85	1.5	3.5	350/60	DL10
MDL010020D72	1-2	-72	2	-70~+5	1	2	250/130	DL2
MDL010080D72	1-8	-72	2	-70~+5	1	2	250/130	DL2
MDL010180D68	1-18	-70	2.5	-70~+5	1	2.5	250/130	DL2
MDL020040D72	2-4	-72	2	-70~+2	1	2.2	460/150	DL9
MDL020060D72	2-6	-72	2	-70~+5	1	2.2	460/150	DL9
MDL020180D68	2-18	-68	2.5	-65~+5	1	2.5	250/130	DL12
MDL020100D72	2-10	-72	2	-70~+5	1	2	250/130	DL2
MDL040080D72	4-8	-72	2	-70~+5	1	2.2	460/150	DL9
MDL040100D72	4-10	-72	2	-70~+5	1	2	250/130	DL2
MDL060120D72	6-12	-72	2	-70~+5	1	2	250/130	DL2
MDL060180D72	6-18	-72	2	-70~+5	1	2.2	250/130	DL2
MDL080120D72	8-12	-72	2	-70~+5	1	2	250/130	DL2
MDL080140D72	8-14	-72	2	-70~+5	1	2	250/130	DL2
MDL080180D72	8-18	-72	2	-70~+2	1	2.2	420/160	DL10
MDL120180D72	12-18	-72	2	-70~+5	1	2	250/130	DL2
MDL180265D62	18-26.5	-65	3	-60~+2	1.5	2.2	350/150	DL7

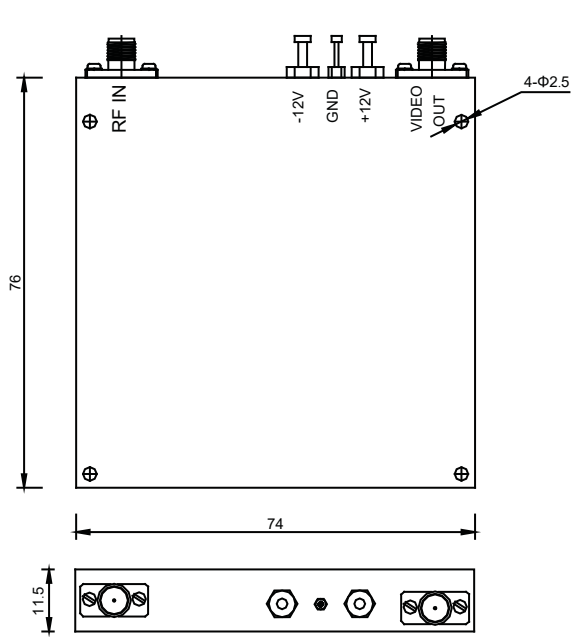

DL2

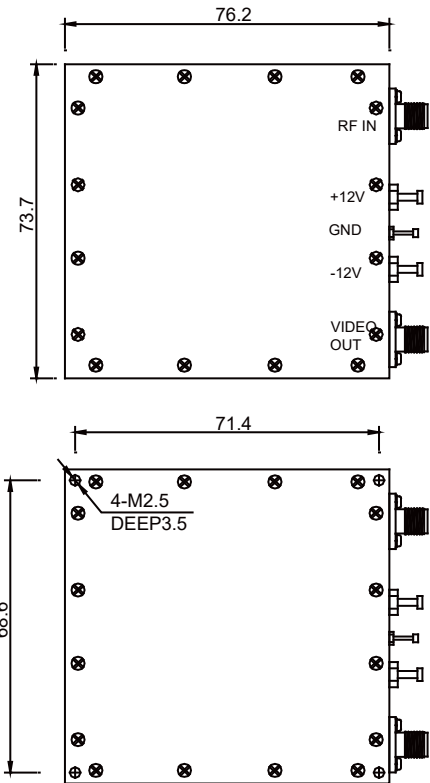
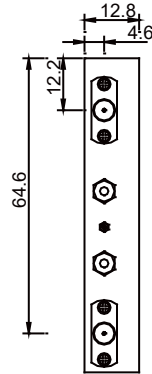

DL10

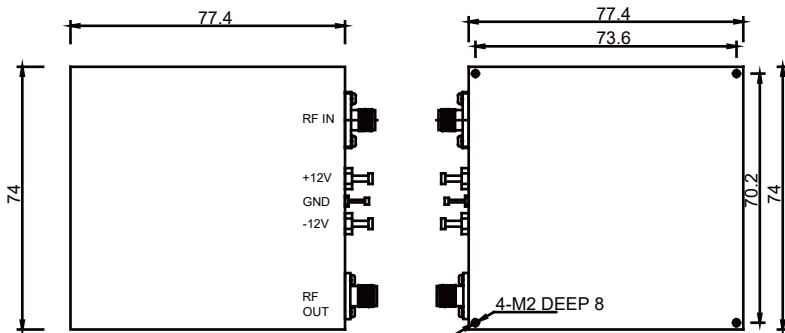

DL7

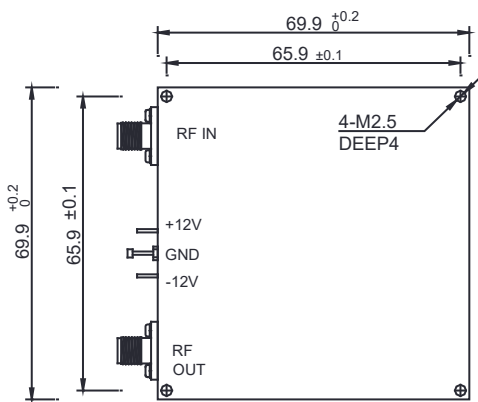
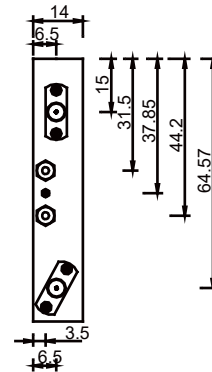

DL9

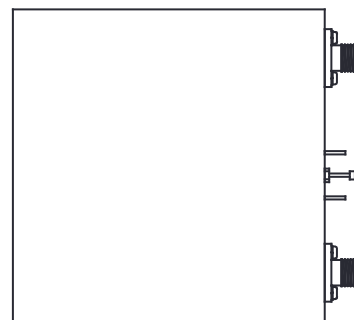
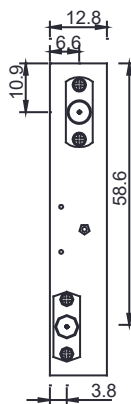

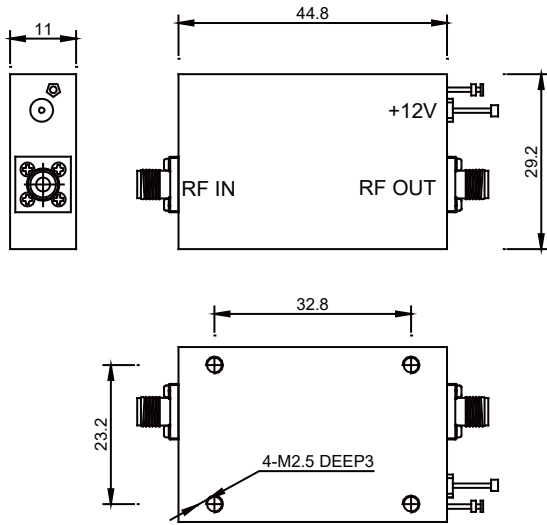

DL11

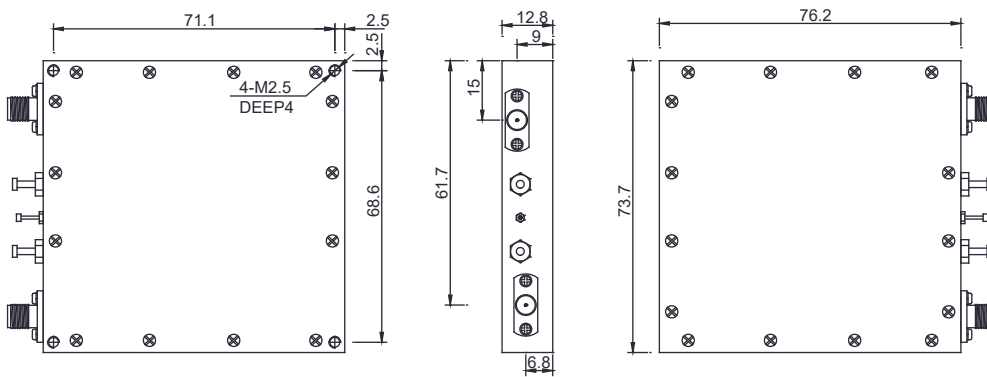

DL12